

REVISED DISPLAY RULES & REGULATIONS

DIVERSIFIED COMMUNICATIONS

121 Free Street
P.O. Box 7437
Portland, ME 04112-7437

In an effort to allow exhibitors to enhance their displays, we have increased the height requirements on booths where possible. Pay close attention to the change in height restrictions for Island, Peninsula and Perimeters Booths. All line of sight regulations still apply for all exhibit space.

Display Rules and Regulations have been with us since expositions began. Each of us recognize the need for certain limitations but many have never taken the time to understand the intent of such rules, why the rules were written, what the rules are expected to accomplish and most importantly, how you as an exhibitor can use them effectively.

The International Association of Exhibitions and Events (IAEE) Guidelines for Display Rules and Regulations were originally created to promote continuity and consistency among North American exhibitions. Since their introduction, they have become the model for most domestic exhibitions.

This revised edition of IAEE's Guidelines is offered as a resource to create consistent and fair exhibiting standards for events. The text and illustrations have been clarified and updated with the intent of affording exhibitors a maximum return on their exhibit investments.

The tenet on which all show management is based can be summed up as follows:

"All exhibitors are equal regardless of size and should be given an equal opportunity, within reason, to present their product in the most effective manner to the audience."

Experience proves that exposition management must establish rules or guidelines to make this possible while allowing the greatest flexibility within each exhibit.

The exhibitor's responsibility can be summed up far more simply:

"Be a good neighbor."

With these thoughts in mind, please review the rules and regulations outlined on the following pages. By following these regulations you can be reasonably sure you will always be "a good neighbor".

Inline Booth

Inline Booths booths, are generally arranged in a straight line and have neighboring exhibitors on their immediate right and left, leaving only one side exposed to the aisle.

Dimensions

For purposes of consistency and ease of layout and/or reconfiguration, floor plan design in increments of 10ft (3.05m) has become the de facto standard in the United States. Therefore, unless constricted by space or other limitations, Inline Booths are most commonly 10ft (3.05m) wide and 10ft (3.05m) deep, i.e. 10ft by 10ft (3.05m by 3.05m). The maximum back wall height limitations is 8ft (2.44m).

Use of Space

Regardless of the number of Inline Booths utilized, e.g. 10ft by 20ft (3.05m by 6.10m), 10ft by 30ft (3.05m by 9.14m), 10ft by 40ft (3.05m by 12.19m), etc. display materials should be arranged in such a manner so as not to obstruct sight lines of neighboring exhibitors. The maximum height of 8ft (2.44m) is allowed only in the rear half of the booth space, with a 4ft (1.22m) height restriction imposed on all materials in the remaining front half of the booth space. Note: When three or more Inline Booths are used in combination as a single exhibit space, the 4ft (1.22m) height limitation is applied only to that portion of exhibit space which is within 10ft (3.05m) of an adjoining booth.

Corner Booth

A Corner Booth is an Inline Booth at the end of a series of in-line booths with exposure to intersecting aisles on two sides. All other guidelines for Inline Booths apply.

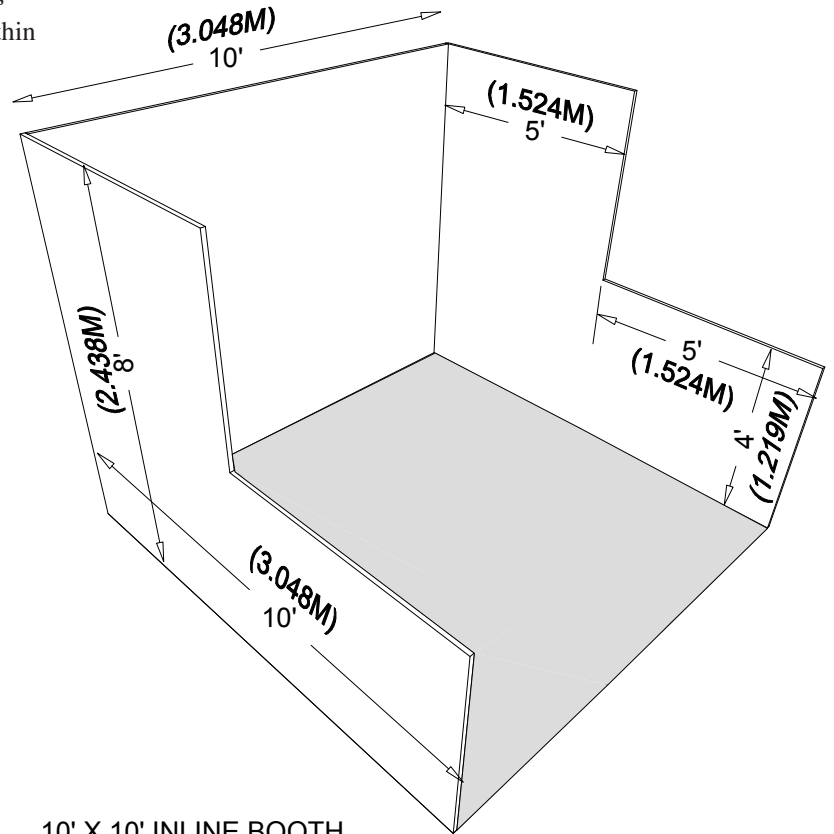
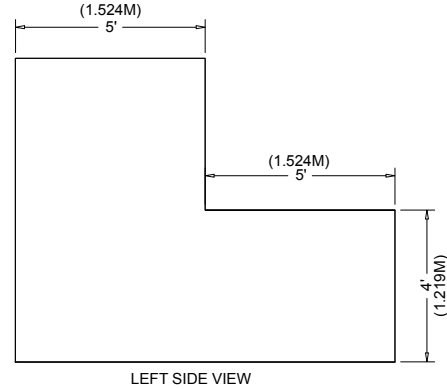
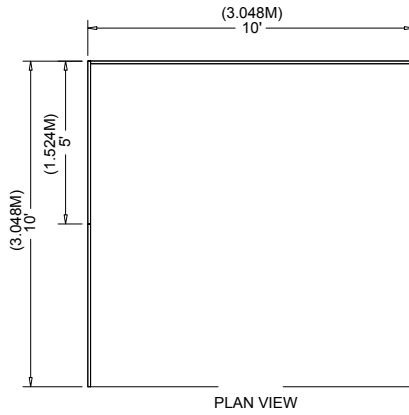

10' X 10' INLINE BOOTH

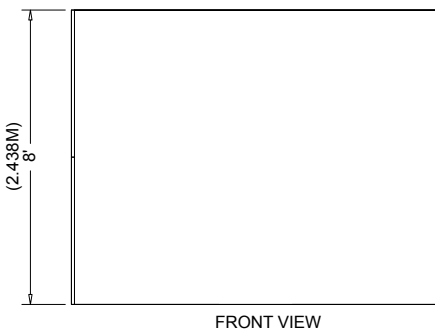

FRONT VIEW

Perimeter Booth

A Perimeter Booth is an Inline Booth located on the outer perimeter of the exhibit floor, typically backing up to an outside wall of the facility and not to another exhibit.

Dimensions and Use of Space

All guidelines for Inline Booths apply to Perimeter Booths except that the maximum back wall height is 14ft (4.27m).

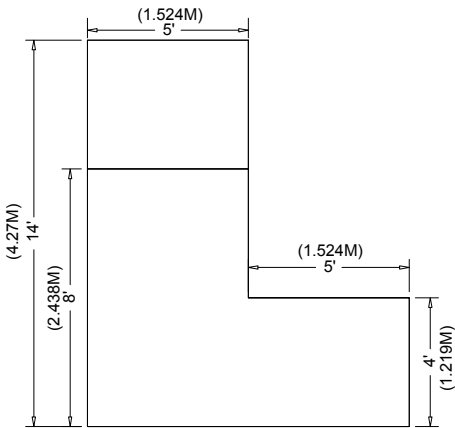
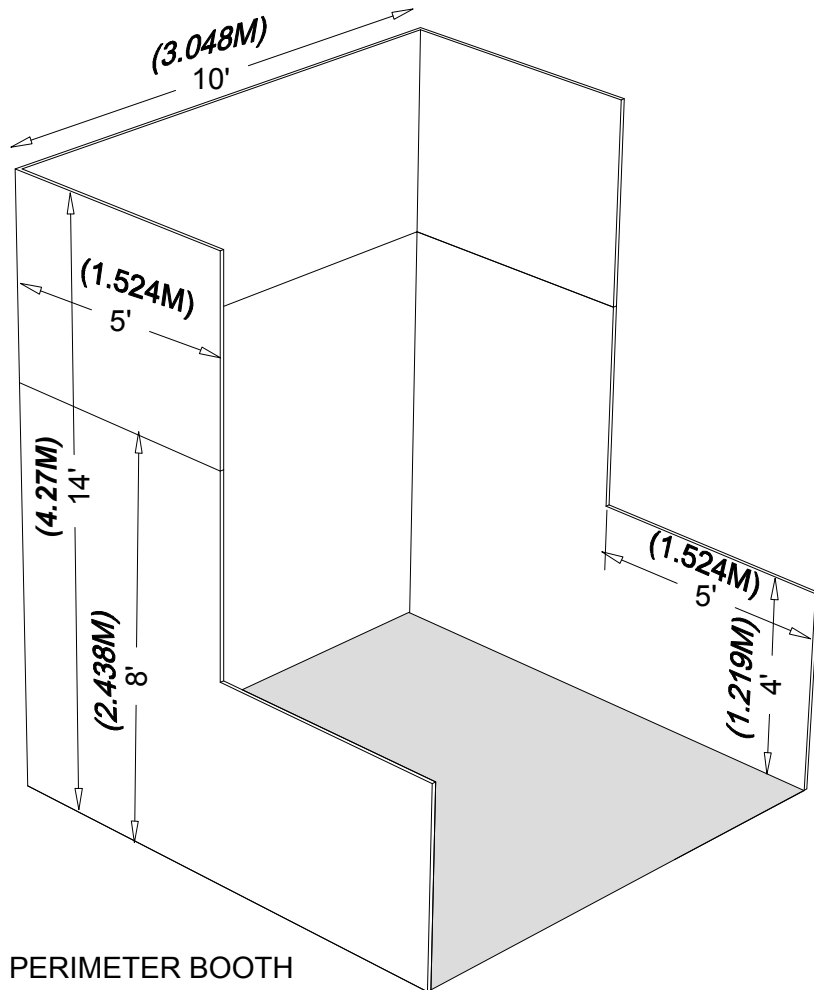
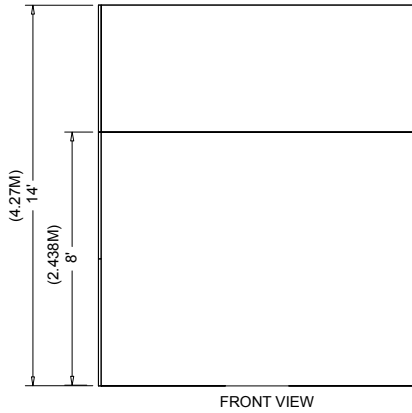
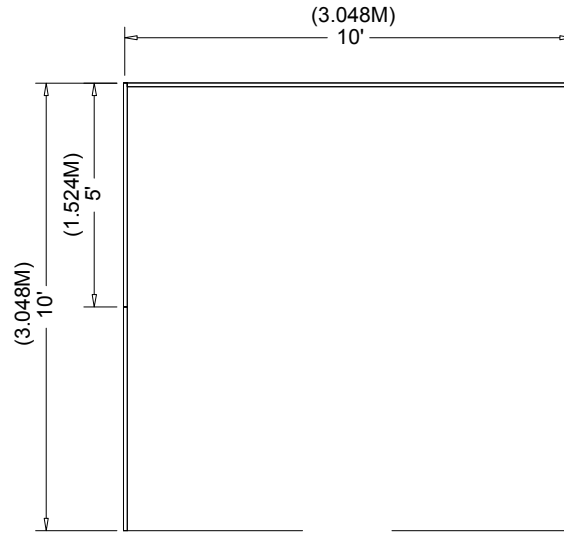

10' X 10' PERIMETER BOOTH

End-cap Booth

An End-cap configuration is essentially an in-line booth placed in the position of a Peninsula or Split Island. For shows that have Line-of-Sight rules and not cubic content, this configuration must follow the dimensions below. For shows that have cubic content rules, the space may be used without restriction

Dimensions

End-cap Booths are generally 10ft (3.05m) deep by 20ft (6.10m) wide. The maximum back wall height allowed is 8ft (2.44m) and the maximum back-wall width allowed is 10ft (3.05m) at the center of the back-wall with a maximum 5ft (1.52m) height on the two side aisles. Within 5' of the 2 side aisles, the maximum height for any display materials is 4'.

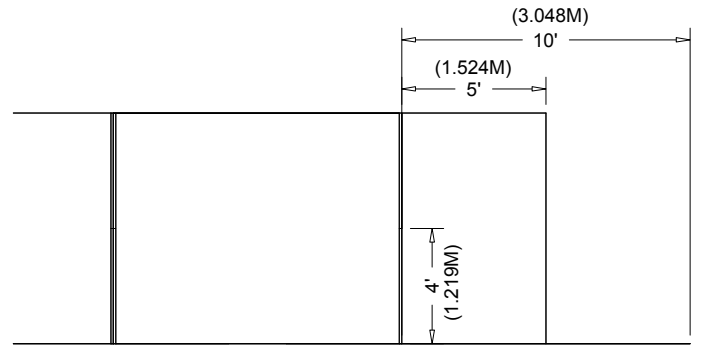

LEFT SIDE VIEW

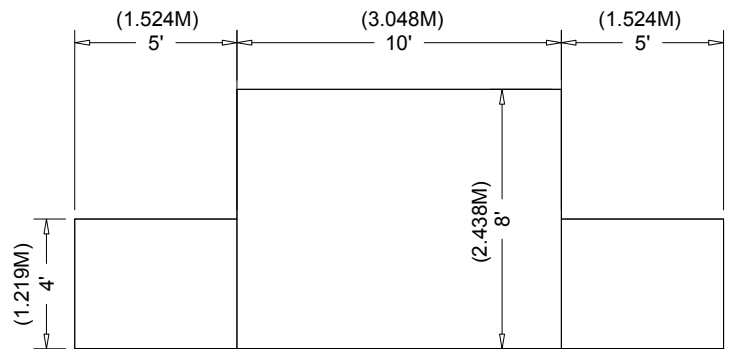

FRONT VIEW

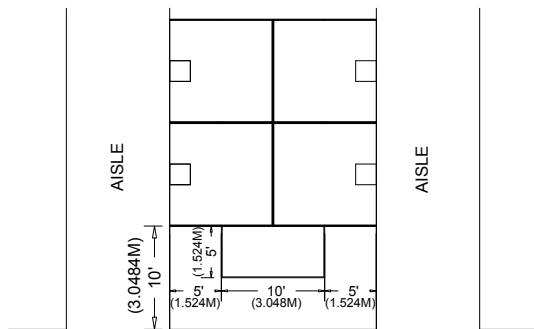

PLAN VIEW

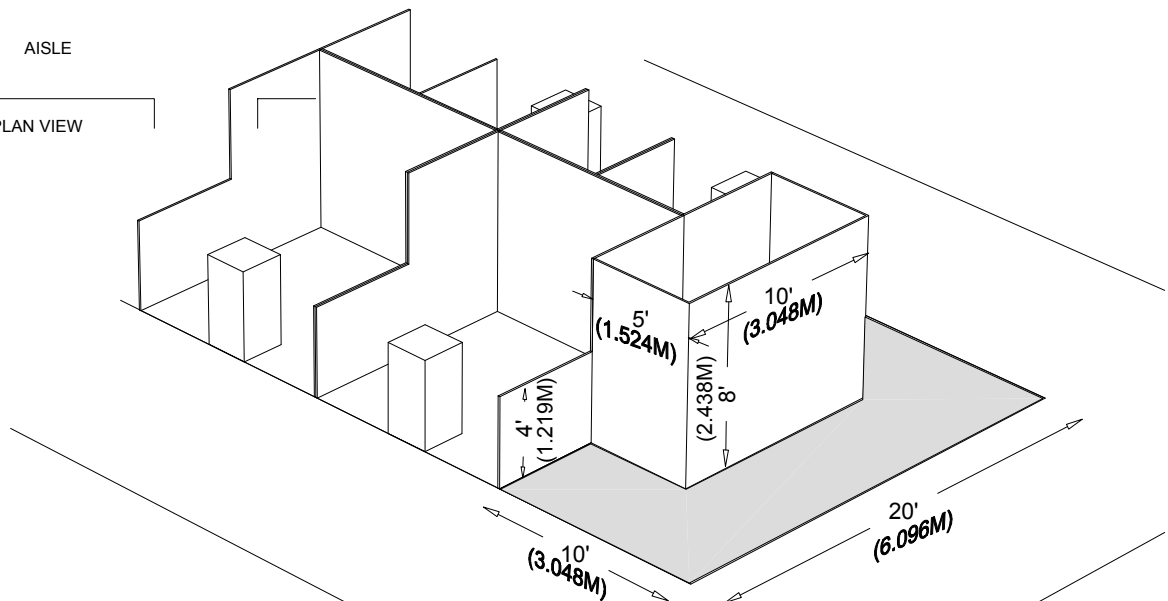

END-CAP BOOTH

Peninsula Booth

A Peninsula Booth is exposed to aisles on three sides, and comprised of a minimum of four booths.

Dimensions

A Peninsula Booth is usually 20ft by 20ft (6.10m by 6.10m) or larger. When a Peninsula Booth backs up to two Inline Booths, the back wall is restricted to 4ft (1.22m) high within 5ft (1.52m) of each aisle, and 10' (3.05m) out from the back wall permitting adequate line of sight for the adjoining Inline Booths. The maximum height allowance is 20ft (6.10m), including signage, for the center portion of the back wall as long as ceiling heights allow. Double-sided signs, logos and graphics must be set back a minimum of five feet (5') (1.52m) from adjacent booths. The back wall facing into the neighbors booth must be devoid of any graphics, text, logos and must be a clean neutral finish.

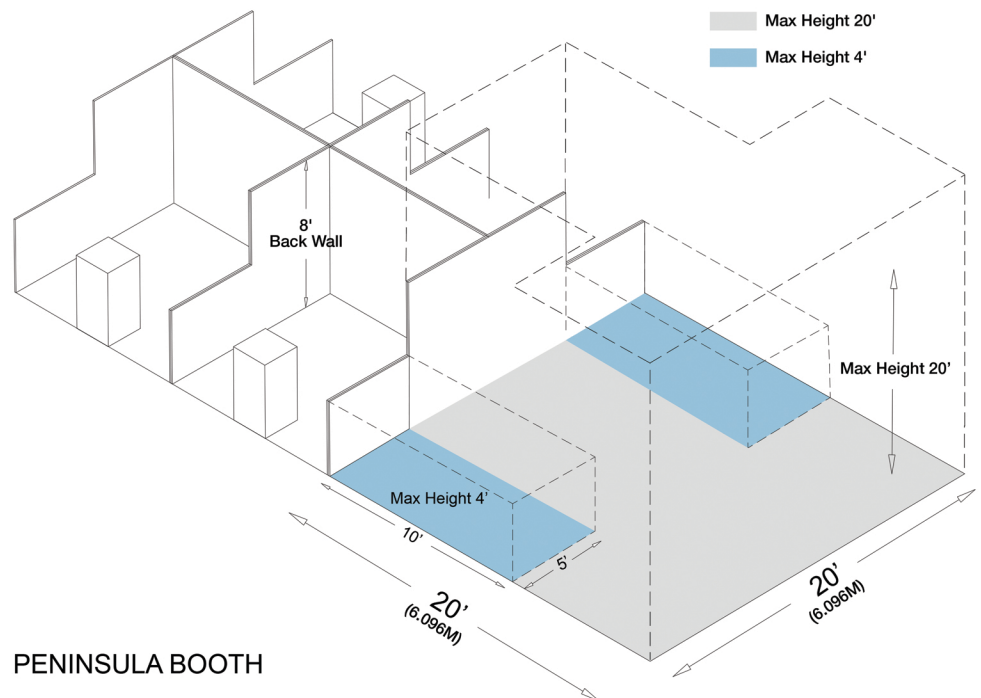
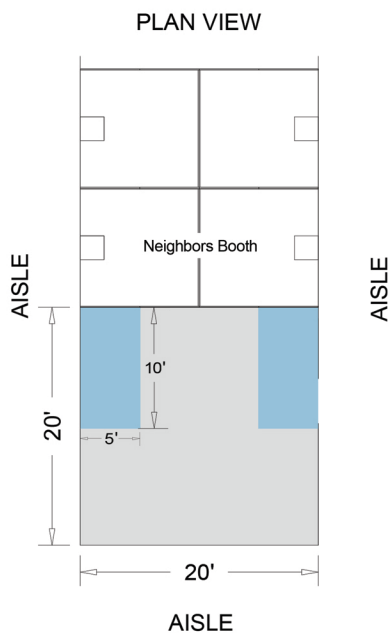
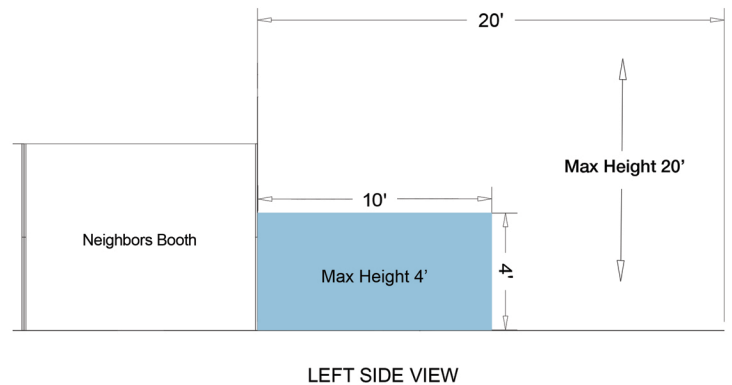
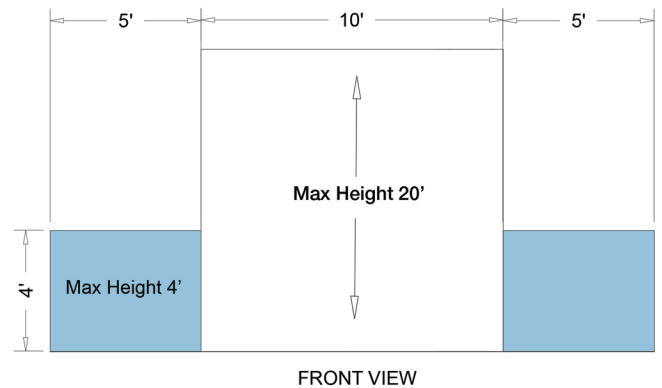

Split Island Booth

A Split Island Booth is a Peninsula Booth which shares a common back wall with another Peninsula Booth. The entire cubic content of this booth may be used, up to the maximum allowable height, without any back wall Line-of-Sight restrictions. The maximum height is 20ft (6.10m), including signage. Double-sided signs, logos and graphics must be set back a minimum of five feet (5') (1.52m) from adjacent booths.

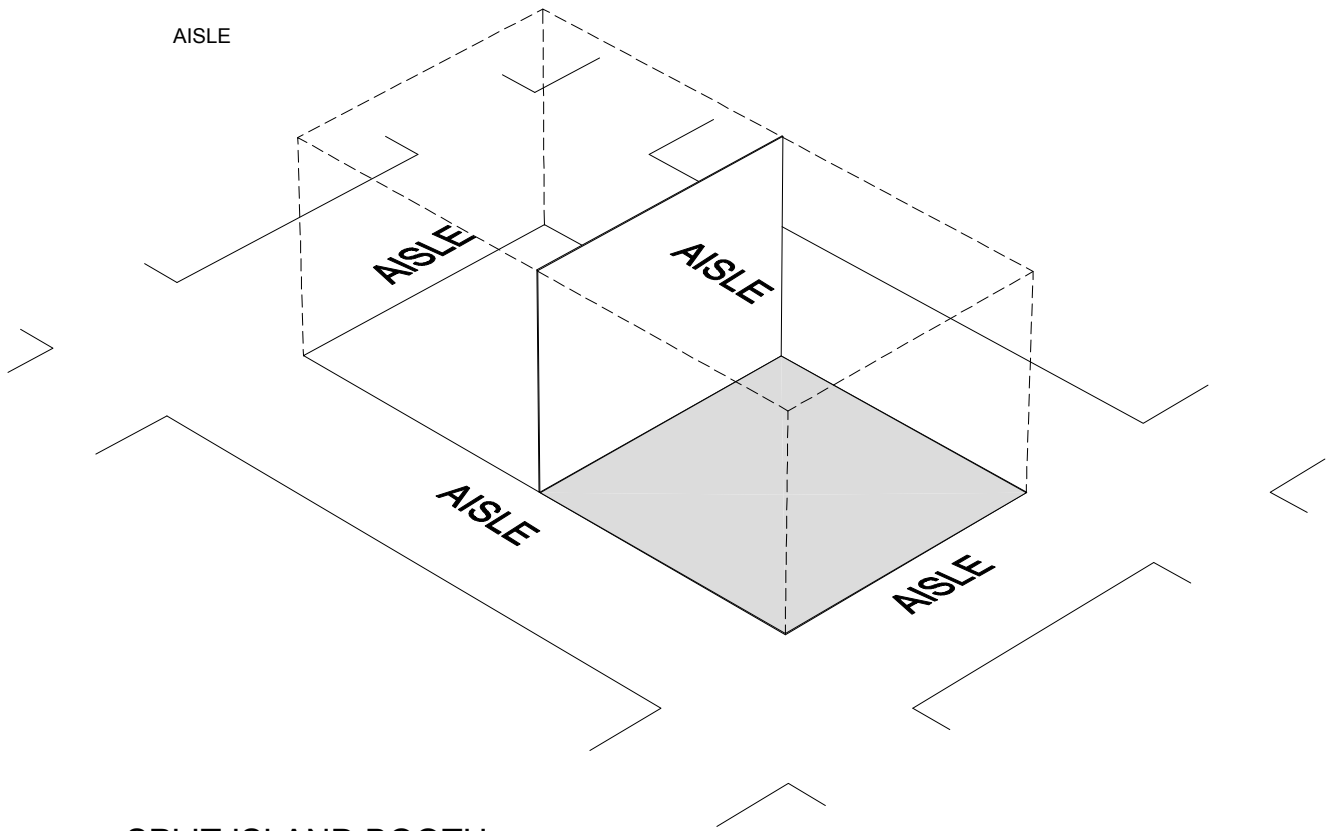
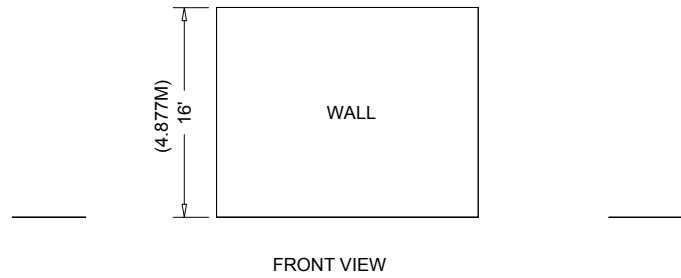
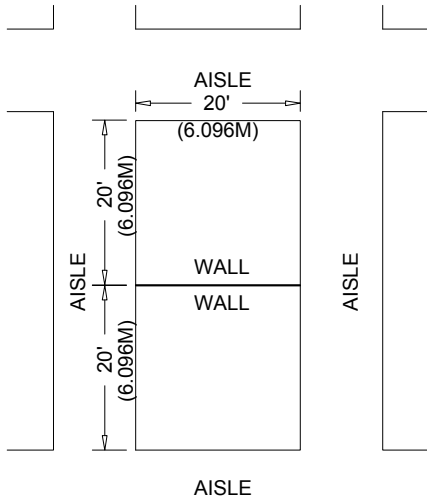
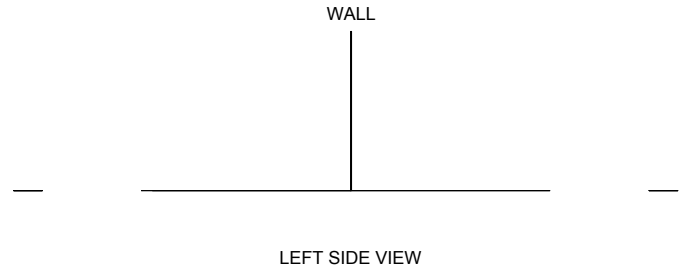

SPLIT ISLAND BOOTH

Island Booth

An Island Booth is at least 20' x 20' in size and is exposed to aisles on all four sides.

Dimensions

An Island Booth is 20ft by 20ft (6.10m by 6.10m) or larger, although it may be configured differently.

Use of Space

The entire cubic content of the space may be used up to the maximum allowable height, which is 20ft (6.10m), including signage as long as ceiling heights allow.

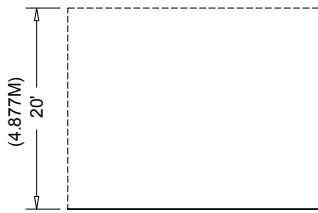
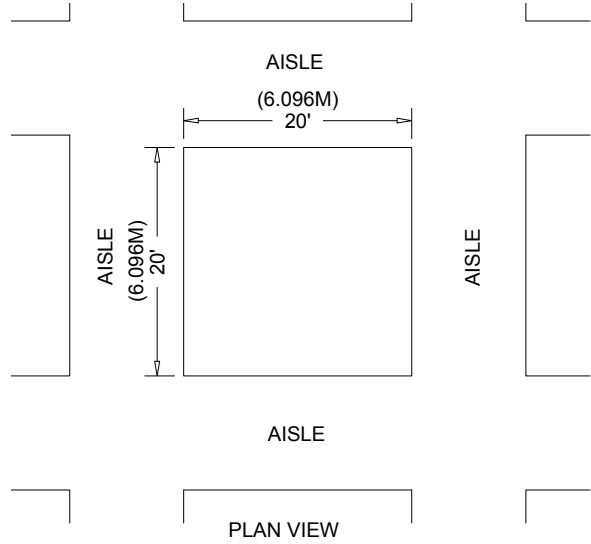

FRONT VIEW

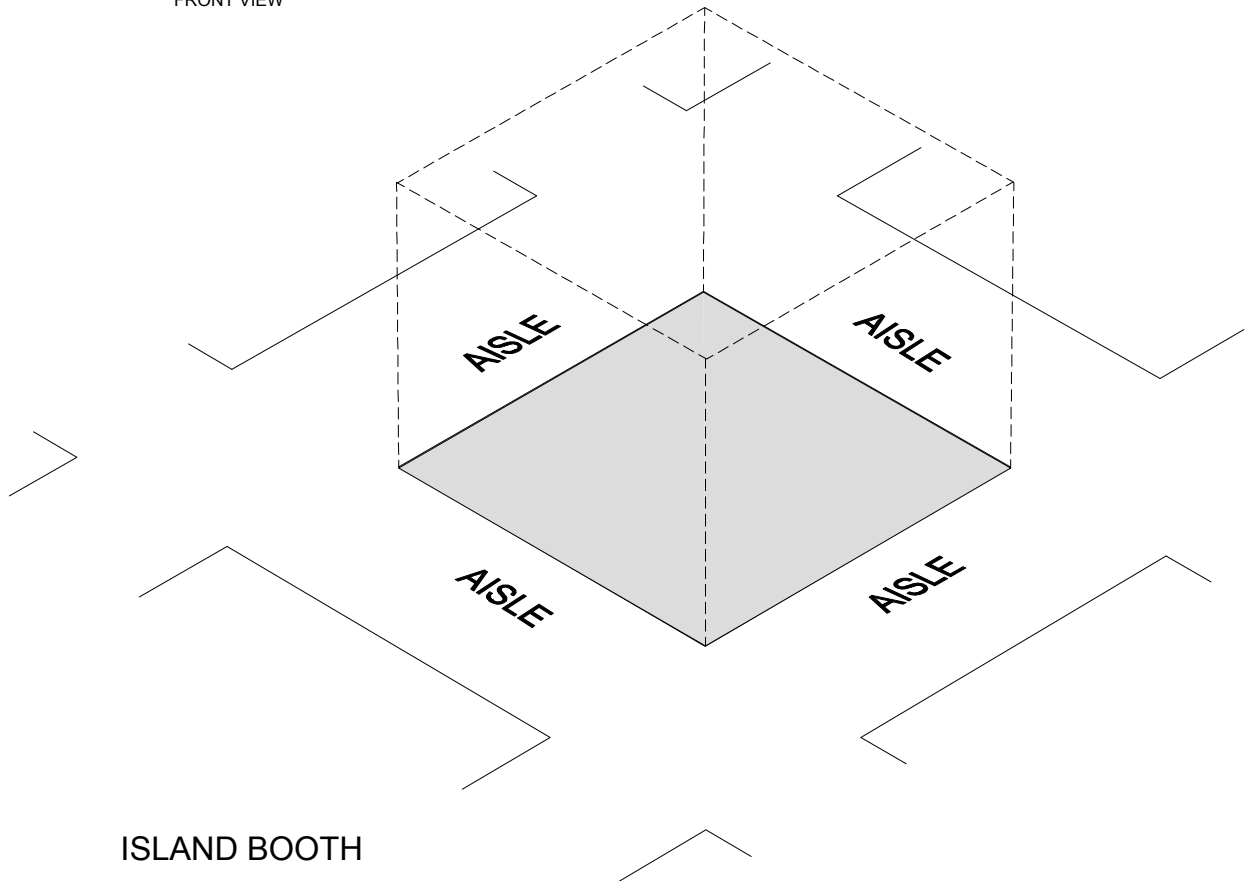

Other Important Considerations

Canopies and Ceilings

Canopies, including ceilings, umbrellas and canopy frames, can be either decorative or functional (such as to shade computer monitors from ambient light or to allow for hanging products). Canopies for Inline or Perimeter Booths must comply with Line-of-Sight requirements and height restrictions. (See “Use of Space” for Inline or Perimeter Booths). Canopies are not allowed in 10ft (3.048M) x 10ft (3.048M) Inline or Perimeter Booths. Canopies are only allowed in 10ft (3.048M) x 20ft (6.096M) corners or larger booth and must adhere to line of sight regulations; meaning canopy structure must be 10' (3.048M) away from neighboring booths. Use of canopies must be approved by Event Management.

The bottom of the canopy should not be lower than 7ft (2.13m) from the floor within 5ft (1.52m) of any aisle. Canopy supports should be no wider than three inches 3in (.08m). This applies to any booth configuration that has a sight line restriction, such as a Inline Booth. Fire and safety regulations in many facilities strictly govern the use of canopies, ceilings and other similar coverings. Check with the appropriate local agencies prior to determining specific exhibition rules.

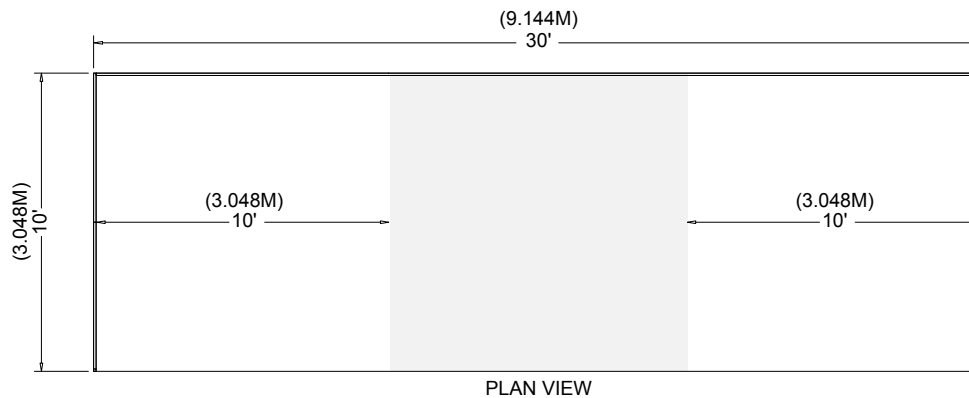

Hanging Signs & Graphics

Most exhibitions and events rules allow for Hanging Signs and Graphics in all standard Peninsula and Island Booths, usually to a maximum height of 20ft (6.10m) from the top of the sign, or as determined by the show organizer. Some events also allow Perimeter Booths to have a hanging sign to a maximum height of 14ft (4.27M). All designs must be reviewed and approved by Event Management. The distance is measured from the floor to the top of the sign. Whether suspended from above, or supported from below, they should comply with all ordinary use-of-space requirements. For example, the highest point of any sign should not exceed the maximum allowable of 20' (6.10M) as long as ceiling heights allow. End-cap Booths and Inline Booths are not permitted to have hanging signs.

Hanging Signs and Graphics should be set back 5ft (1.52m) from adjacent booths and be directly over contracted space only.

Approval for the use of Hanging Signs and Graphics, at any height, should be received from the exhibitions or events organizer at least 60 days prior to installation. Drawings should be available for inspection.

Towers

A Tower is a free-standing exhibit component separate from the main exhibit fixture. The height restriction is the same as that which applies to the appropriate exhibit space configuration being used.

Towers in excess of 8ft (2.44m) should have drawings available for inspection. Fire and safety regulations in many facilities strictly govern the use of Towers. A building permit or safety lines may be required.

Multi-story Exhibit

A Multi-story Exhibit is a booth where the display fixture includes two or more levels. In many cities, a Multi-story Exhibit requires prior approval by the exhibit facility, and/or relevant local government agency, as well as show management because it is deemed to be a “structure” for building purposes. The city building department generally needs to issue a building permit based on an application and drawings prepared and submitted by a licensed architect or engineer. Exhibitors should obtain local building regulations early on to ensure that all time constraints are met. Exhibitions and events organizers should be prepared to assist exhibitors in this application process.

Issues Common To All Booth Types

Americans with Disabilities Act (ADA)

All exhibiting companies are required to be in compliance with the Americans with Disabilities Act (ADA), and are encouraged to be sensitive, and as reasonably accommodating as possible, to attendees with disabilities. Information regarding ADA compliance is available from the U.S. Department of Justice ADA Information Line (800) 514-0301, and from the ADA website at www.ada.gov. Some examples of how to design an exhibit for ADA compliance:

- Make exhibits wheelchair accessible by ramping raised exhibit flooring without extending a ramp into the aisle. Note: a standard wheelchair ramp should have a grade no steeper than 1:12. This means that for every inch of rise (change in height), there should be 12 inches of run (change in length)
- Ramp the entry or use hydraulic lifts to trailer exhibits
- Avoid double-padded plush carpet to ease mobility device navigation
- Provide the same attendee experience on both levels of a two-story exhibit
- Offer a signer or other auxiliary hearing-impaired apparatus for sound presentations or have a printed copy of the presentation available
- Run an audio presentation for people with sight problems
- Arrange touch screen displays at a height to accommodate a person sitting in a wheelchair

To avoid heavy fines by the U. S. Department of Justice, exhibitors must adhere to the ADA rules. Exhibits are not exempt from ADA compliance.

Structural Integrity

All exhibit displays should be designed and erected in a manner that will withstand normal contact or vibration caused by neighboring exhibitors, hall laborers, or installation/dismantling equipment, such as fork lifts. Displays should also be able to withstand moderate wind effects that may occur in the exhibit hall when freight doors are open. Refer to local building codes that regulate temporary structures.

It is recommended that all 20ft by 20ft (6.10m by 6.10m) and over exhibits require a drawing, plans or renderings, preferably digital, to be submitted to the show organizer, and to the show's general service contractor.

Exhibitors should ensure that any display fixtures such as tables, racks, or shelves are designed and installed properly to support the product or marketing materials to be displayed.

Flammable and Toxic Materials

All materials used in display construction or decorating should be made of fire retardant materials and be certified as flame retardant. Samples should also be available for testing. Materials that cannot be treated to meet the requirements should not be used. A flame-proofing certificate should be available for inspection. Exhibitors should be aware of local regulations regarding fire/safety and environment which must be adhered to.

Exhibitors should dispose of any waste products they generate during the exhibition in accordance with guidelines established by the Environmental Protection Agency and the facility.

Storage

Fire regulations in exhibit facilities prohibit storing product, literature, empty packing containers, or packing materials behind back drapes or under draped tables. In most cases, however, exhibitors may store a limited supply of literature or product appropriately within the booth area, so long as these items do not impede access to utility services, create a safety problem, or look unsightly.

Issues Common To All Booth Types *(continued)*

Lighting

Exhibitors should adhere to the following suggested minimum guidelines when determining booth lighting:

- No lighting, fixtures, lighting trusses, or overhead lighting are allowed outside the boundaries of the exhibit space. Exhibitors intending to use hanging light systems should submit drawings to exhibition management for approval.
- Lighting, including gobos, should be directed to the inner confines of the booth space. Lighting is not permitted to project onto other exhibits or exhibition aisles.
- Lighting that is potentially harmful, such as lasers, ultraviolet lights or flashing or strobe lights that can trigger photosensitive epilepsy should comply with facility rules and be approved in writing by exhibition management.
- Lighting that spins, rotates, pulsates, and other specialized lighting effects should be in good taste and not interfere with neighboring exhibitors or otherwise detract from the general atmosphere of the event.
- LED lights can be very bright yet generally generate less heat.
- Currently, some convention facilities are not allowing certain types of quartz halogen lighting fixtures in exhibits due to potential fire hazards. Check with exhibition management.
- Reduced lighting for theater areas should be approved by the exhibition organizer, the utility provider, and the exhibit facility.

Demonstrations

As a matter of safety and courtesy to others, exhibitors should conduct sales presentations and product demonstrations in a manner which assures all exhibitor personnel and attendees are within the contracted exhibit space and not encroaching on the aisle or neighboring exhibits. It is the responsibility of each exhibitor to arrange displays, product presentation, audio visual presentations, and demonstration areas to ensure compliance. Exhibitors should be aware of local regulations regarding fire/safety and environment which must be adhered to.

Special caution should be taken when demonstrating machinery or equipment that has moving parts, cooking equipment with an open flame, or any product that is otherwise potentially dangerous. Exhibitors should establish a minimum setback of 3ft (.91m) and/or install hazard barriers as necessary to prevent accidental injury to spectators. Additionally, demonstrations should only be conducted by qualified personnel. If you are planning on having a demonstration within your booth space it must be approved by show management.

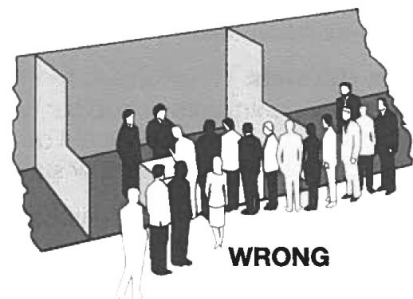
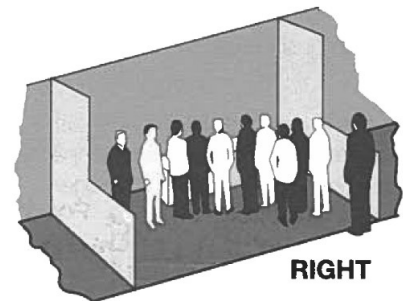

Issues Common To All Booth Types *(continued)*

Sound/Music

In general, exhibitors may use sound equipment in their booths so long as the noise level does not disrupt the activities of neighboring exhibitors. Speakers and other sound devices should be positioned so as to direct sound into the booth rather than into the aisle.

Exhibitors should be aware that music played in their booths, whether live or recorded, may be subject to laws governing the use of copyrighted compositions. ASCAP, BMI, and SESAC are three authorized licensing organizations that collect copyright fees on behalf of composers and publishers of music.

Please be a considerate neighbor. Event Management reserves the right to shut down any receptions, presentations, or other activities which are deemed obstructive or prohibitive for neighboring booths to be able to conduct business.

Vehicles

Vehicles: Rules vary depending on the facility, but generally it is required that vehicles on display have no more than one fourth tank of gas. The filler cap should be sealed and the batteries disconnected. External chargers are usually recommended for demonstration purposes. Keys should always be surrendered to the facility while participating in an exhibition or event.